

Atlantic

Premium Shutters™



Specifications Guide

Architectural Specification Reference

Architectural Collection

Manufactured By:

Atlantic Premium Shutters, Latta, South Carolina (O/E)

Nominal Thickness:

1¼" stiles and side rails on Louvered Colonials and Bahamas.

1" on Raised Panels styles.

(other styles subject to special inquiry)

Installation: To be installed in either a fixed or operable condition in accordance with manufacturers recommendations, with no nailing or screwing through face of shutter.

Material: High density structural PVC and/or pultruded fiberglass and/or proprietary composite material. All slats and louvered side rails to be fiberglass.

Finish: Two part acrylic urethane cured by means of microwave thermology and direct infrared heat – 40 standard colors (custom colors available).

Hardware:

Colonial style shutters - Black powder-coated stainless steel – all other brads and fasteners also to be stainless steel.

Bahama - Aluminum with factory applied two part acrylic urethane finish.

Performance: All fiberglass louvers and side rails to be thermally stable from –100°F to +200°F.

Warranties:

1. Lifetime on structural components and against manufacturer defect limited to original purchaser.
2. Fifteen year warranty on factory applied finish.

Classic Collection

Manufactured By:

Atlantic Premium Shutters, Latta, South Carolina (O/E)

Nominal Thickness: Shutters are 1 inch thick (25 mm).

Installation: To be installed in either a fixed or operable condition in accordance with manufacturers recommendations, with no nailing or screwing through face of shutter.

Material: Solid core composite materials.

Finish: Two part urethane paint, oven cured. Hardware: Black powder-coated stainless steel – all other brads and fasteners also to be stainless steel.

Warranties: Provide with a ten year warranty against defects in materials and factory paint finish.

General Notes

To deflect rain away from the structure, louvered shutters should be installed so the louvers face AWAY from the structure when shutters are closed.

Shutter swing is 3" per shutter from the edge of the shutter to the edge of the window opening; be sure to check for proper clearance (i.e. lamps, fixtures) when the shutter is in the open position.

Hinges are usually applied to the back of the shutter. They are only visible in their entirety when the shutter is in the closed position.

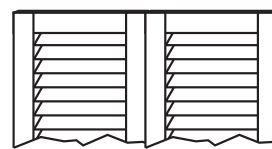



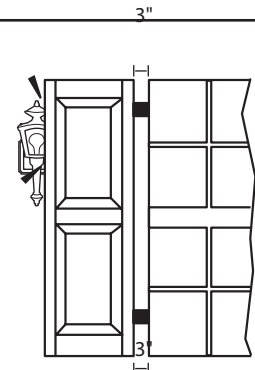



Shutters in closed position

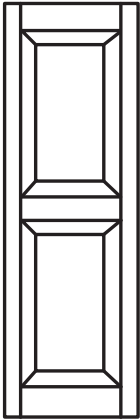

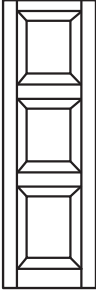
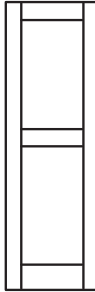
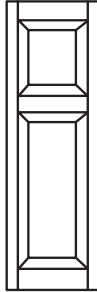
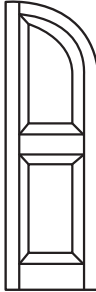
Ensure proper clearance of shutters.

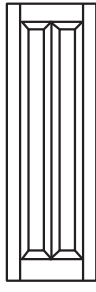
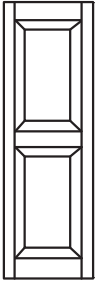
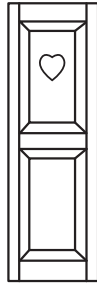
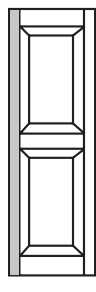
Architectural Collection

Raised Panel					
Standard	Options				
	single panel	extra panel	flat panel	custom rail location	arch or radius top
					
	v-groove	single panel with vertical cut profile	rabbeted edge with beading	cut out	butt hinge
					

Rails	Structural PVC with smooth outer skin.
Panels	Proprietary composite materials.
Louvers	—
Stiles	Pultruded Structural Fiberglass
Paint Finish	Two-part Urethane
Thickness	1"
Width	12"-36" (in 1/8" increments)
Height	13 1/2"-120" (in 1/8" increments)
Vertical Stile	2 1/2"
Top Rail	3"
Middle Rail	3"
Bottom Rail	3"
Diagrams	

Architectural Collection

Louvered Colonial

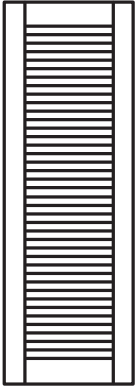
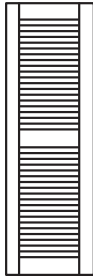
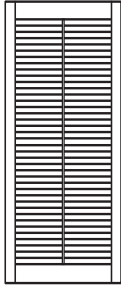
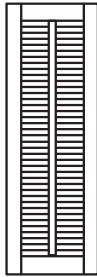
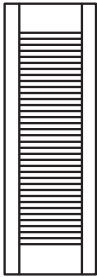
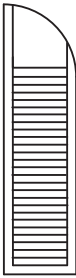
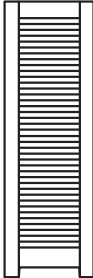
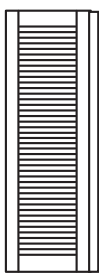
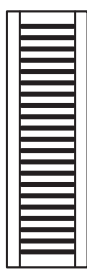
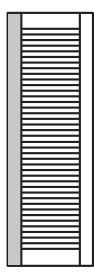
Standard	Options				
	additional rails	vertical mullion		faux tilt rod	custom top or bottom rail
					
	solid arch top	horns	rabbeted edge	bahama louver spacing	butt hinge
					

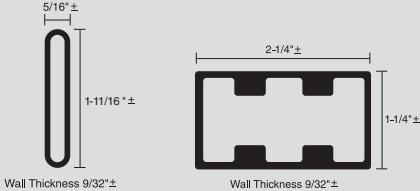
Rails	Structural PVC with smooth outer skin.
Panels	—
Louvers	Pultruded Structural Fiberglass
Stiles	Pultruded Structural Fiberglass
Paint Finish	Two-part Urethane
Thickness	1 1/4"
Width	9"-36" (in 1/8" increments) Rail widths, if specified, may vary slightly due to louver/slat positioning. Vertical mullion required for every 30"
Height	13 1/2"-120" (in 1/8" increments)
Vertical Stile	2 1/4"
Top Rail	4"
Middle Rail	3 3/8"
Bottom Rail	4" (may vary)
Diagrams	

Architectural Collection

Combination

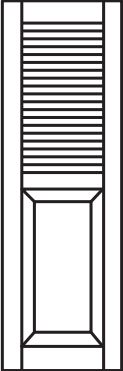
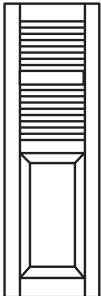
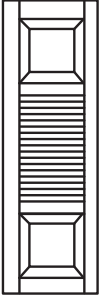
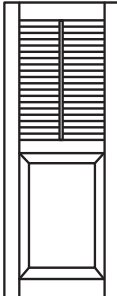
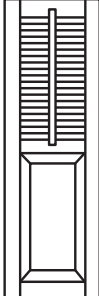
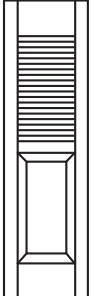
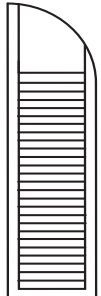
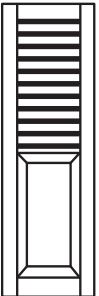
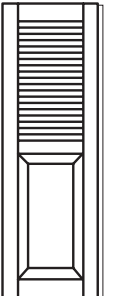
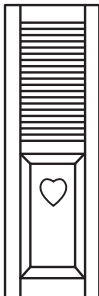
Standard	Options				
	additional rails	extra panel	vertical mullion	faux tilt rod	custom rail sizes
					
	solid panel arch top	bahama louver spacing	rabbeted edge	cut out	
					

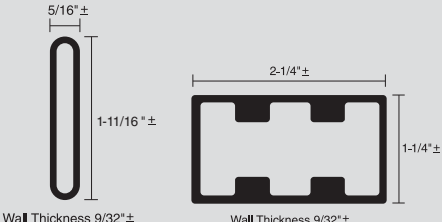
Rails	Structural PVC with smooth outer skin.
Panels	Proprietary Composite Material.
Louvers	Pultruded Structural Fiberglass
Stiles	Pultruded Structural Fiberglass
Paint Finish	Two-part Urethane
Thickness	1 1/4"
Width	12"-36" (in 1/8" increments) Rail widths, if specified, may vary slightly due to louver/slat positioning. Vertical mullion required for every 30"
Height	24"-120" (in 1/8" increments)
Vertical Stile	2 1/4"
Top Rail	3"
Middle Rail	3"
Bottom Rail	4"
Diagrams	

Architectural Collection

Bahama

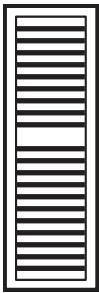
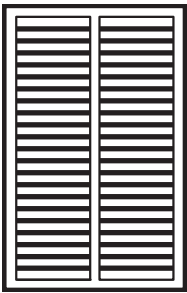
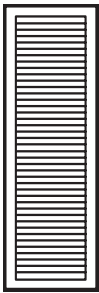
Standard	Options		
	additional rails 	additional vertical mullion 	colonial louver spacing 

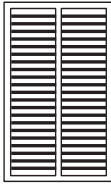
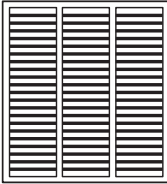
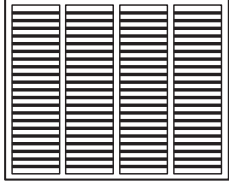

Rails	Pultruded Structural Fiberglass
Slats	Pultruded Structural Fiberglass
Stiles	Pultruded Structural Fiberglass
Paint Finish	Two-part Urethane
Width	12"-119" (in 1/8" increments)
Thickness	1 1/4"
Height	18 1/2"-119" (in 1-1/2" increments)
Vertical Stile	2 1/4"
Top Rail	2 1/4"
Middle Rail	2 1/4"
Bottom Rail	2 1/4"

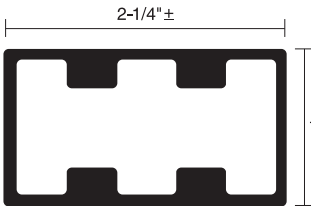
Notes	<p>Shutter widths from 30" – 59" require 1 vertical mullion. Shutter widths from 60" – 89" require 2 vertical mullion. Shutter widths from 90" – 119" require 3 vertical mullion.</p> <p>Additional vertical mullions available upon request.</p> <div style="display: flex; justify-content: space-around; align-items: flex-end;"> <div style="text-align: center;"> <p>less than 30"</p>  </div> <div style="text-align: center;"> <p>30" to less than 60"</p>  </div> <div style="text-align: center;"> <p>60" to less than 90"</p>  </div> <div style="text-align: center;"> <p>90" to less than 120"</p>  </div> </div>
--------------	---

Diagrams	<div style="display: flex; justify-content: space-around; align-items: center;"> <div style="text-align: center;"> <p>5/16" ±</p>  <p>1-11/16" ±</p> <p>Wall Thickness 9/32" ±</p> </div> <div style="text-align: center;"> <p>2-1/4" ±</p>  <p>1-1/4" ±</p> <p>Wall Thickness 9/32" ±</p> </div> </div>
-----------------	--

Classic Collection

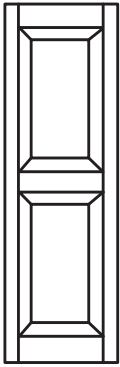
Raised Panel

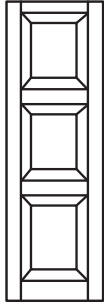
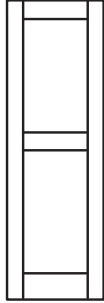
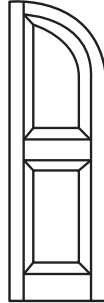
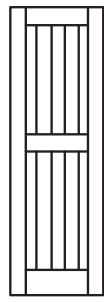
Standard	Options				
	single panel	extra panel	flat panel	arch or radius top	v-groove
					

Rails	Proprietary Composite Material
Panels	Proprietary Composite Material
Stiles	Proprietary Composite Material
Paint Finish	Two-Part Urethane
Width	9"-36" in 1/8" increments
Height	13 1/2"-120" (in 1/8" increments)

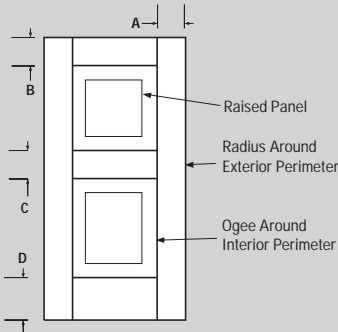
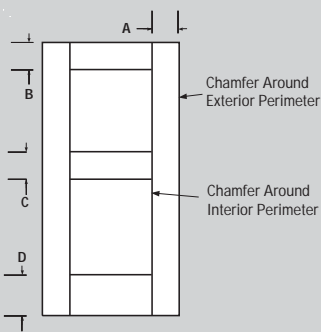
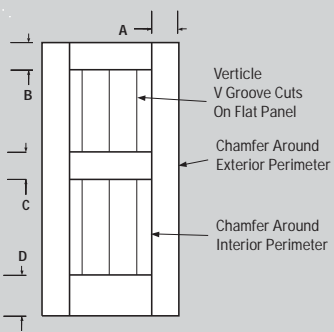
	Raised Panel	Flat Panel	V-Groove
Thickness:	1" and 3/4"	1" and 1/2"	1" and 1/2"
Vertical Stile Width (A):	2 1/2"	2 1/2"	2 1/2"
Top Rail Height (B):	2 1/2"	2 1/2"	2 1/2"
Middle Rail Height (C):	2 1/2"	2 1/2"	2 1/2"
Bottom Rail Height (D):	4 1/8"	4 1/8"	4 1/8"
			

Classic Collection

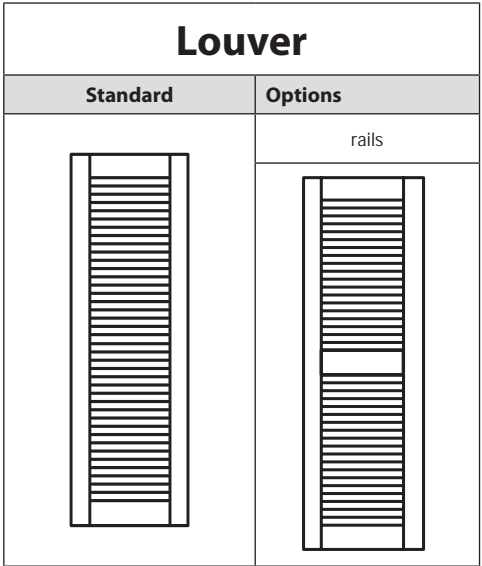

Rails	Proprietary Composite Material
Louvers	Proprietary Composite Material
Stiles	Proprietary Composite Material
Paint Finish	Two-Part Urethane
Width	9"-36" in 1/8" increments
Height	13 1/2"-120" (in 1/8" increments)

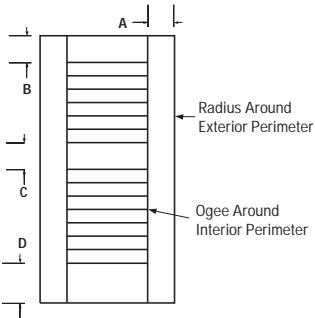
	Louver
Thickness:	1 1/4"
Vertical Stile Width (A):	2 1/2"
Top Rail Height (B):	2 1/2"
Middle Rail Height (C):	2 1/2"
Bottom Rail Height (D):	2 3/4"-4"
Louver Angle:	22°
	

Classic Collection

Board and Batten

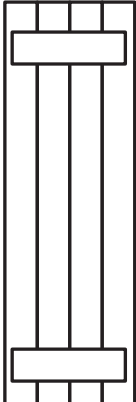
Standard	Options					
	z-bar	extra batten	no battens	arch or radius top	cut out	custom horizontal or diagonal grooves

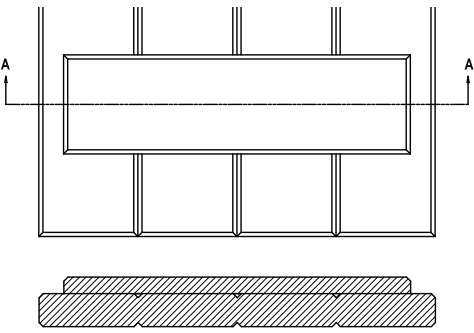
Rails	Proprietary composite materials.
Panels	Proprietary composite materials.
Stiles	Proprietary composite materials.
Paint Finish	Two-part Urethane
Thickness	1 1/2"
Width	9"-36" (in 1/8" increments)
Height	Height: 13 1/2"-120" (in 1/8" increments)
Batten Height	4"
Batten Width	Panel width - less 1 1/2"
Diagrams	 <p style="text-align: center;">SECTION A-A</p>

Traditional Hardware

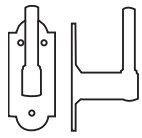

Pintel on Plate

- Sold in pairs
- Pintel plate size - 11/2" x 31/2" x 1/8" Pin diameter - 3/8"
- Stainless Steel with a matte black powder coat finish
- Offsets: 1/2", 11/2", 21/4", 33/4"

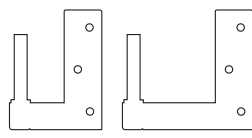

Jamb Pintel Offset - 1", 2"

- Sold in pairs
- Stainless Steel with a matte black powder coat finish

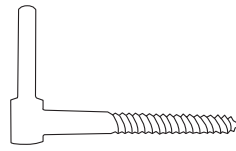

4" Lag Pintel

- Sold in pairs
- Stainless Steel with a matte black powder coat finish
- Pin diameter: 3/8"



Pintel Shim

- Sold in eaches
- Shim is 1/4" thick and stackable
- Black Polyamide Plastic

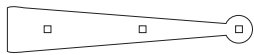

10" Strap Hinge

- Sold in same size pairs
- Stainless Steel with a matte black powder coat finish
- Offsets: 0", 1/2", 11/2", 21/4"



12" Strap Hinge

- Sold in same size pairs
- Stainless Steel with a matte black powder coat finish
- Offsets: 1/2", 11/2"

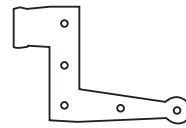

6" L-Hinge

- Sold in pairs
- Stainless Steel with a matte black powder coat finish
- Offsets: 0", 1/2", 11/2", 21/4"

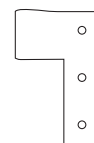

Flat Hinge

- Sold in pairs
- Stainless Steel with a matte black powder coat finish
- Offset: 0", 1/2", 11/2", 2 1/4"



10" Backplate

- Sold in pairs
- Stainless Steel with a matte black powder coat finish



12" Backplate

- Sold in pairs
- Stainless Steel with a matte black powder coat finish

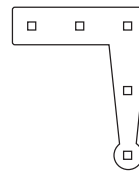

6" L-Hinge Back Plate

- Sold in pairs
- Stainless Steel with a matte black powder coat finish



Flat Hinge Back Plate

- Sold in pairs
- Stainless Steel with a matte black powder coat finish



Acorn Holdback

- Sold in eaches
- Chromed Bronze Bullet
- Stainless Steel Hanger Bolt and Spring Clip

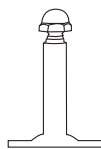

Dog Post Holdback

- Sold in pairs
- Stainless Steel with a matte black powder coat finish



"S" Holdback

- Sold in pairs with 4" lag bolt, washer, cotter pin
- Stainless Steel with a matte black powder coat finish



Rat Tail Holdback

- Sold in pairs
- Stainless Steel with a matte black powder coat finish

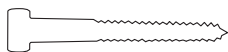

6" Lag Bolt

- Sold in pairs
- Stainless Steel with a matte black powder coat finish
- For use with "S" and Rat Tail holdbacks

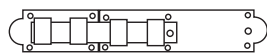

12" Slide Bolt

- Sold in eaches
- Stainless Steel with a matte black powder coat finish

Examples of Common Installation Options - Traditional Hardware

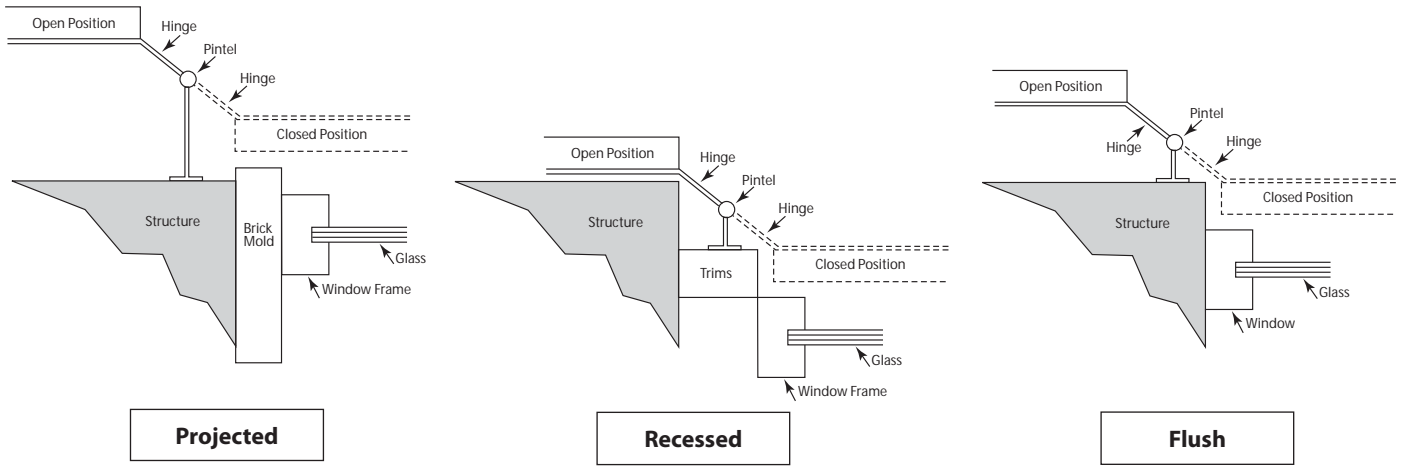

Hinge Requirements

shutter height	12" to 48"	49" to 96"	97" to 144"	144"+
hinge requirement	2	3	4	5

Bahama Hardware

NOTE: Female hinge clearance is not factored into overall shutter height.

Examples of Installation

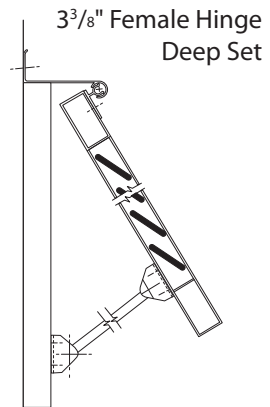
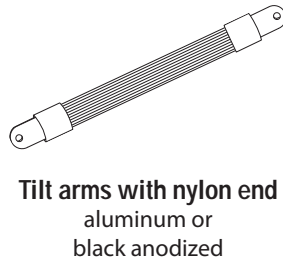
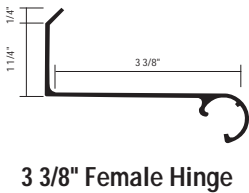
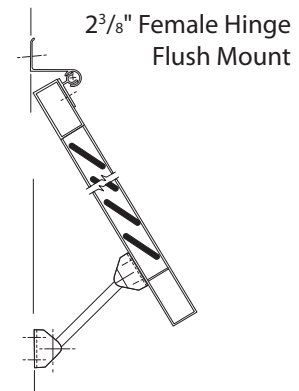
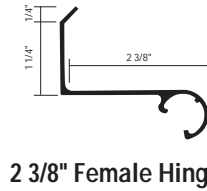

Atlantic
Premium Shutters™

